

Multi-function UP/Down counter

MJ501/MJ701/MJ901

Manual

MJ01-C0NA-C3

- ◇ Output: SP1 count output / Ba1 batch count output / Su1 totalize count output
- ◇ Alarm: SP2 premium output alarm
- ◇ PV2 display selectable: SP1 set value / batch value / totalize value
- ◇ INPUT(Int): NPN Single phase up (IN1) or down (IN2) count (Up/Down counting selectable) Quadrature 90 (IN1/IN2) Up/Down count
- ◇ Value: Count/reverse count
- ◇ Multiplier range (nuL): 0.0001-99.9999
- ◇ Decimal point settable ◇ Batch division (BAP): 1-999999
- ◇ Response frequency: 1-5000HZ selectable
- ◇ Output control settalbe: Manual/self reset/cleaning reset/ output mode: N/r/C/HN/EN/LN/AN/Ar
- ◇ Output reset time settable: 0.01-99.99 second
- ◇ Power-off memory settable (Sut)
- ◇ RS-485 communication: MODBUS-RTU

1. Ordering information

Pls make sure that you know exactly what you are looking for before proceed

CODE NO	MJ	□	-	□	□	□	□	-	B	-	□
		①		②	③	④	⑤		⑥		⑦

- ①. SIZE
 - 501: 96mmx48mm (horizontal)
 - 701: 72mmx72mm
 - 901: 96mmx96mm
- ②. Relay OP1 output
 - N: NO OP1
 - 1: Be used as SP1 count output 2: Be used as SP2 ON/OFF Alarm output
 - 3: Be used as BA1 batch count output 4: Be used as SU1 totalize count output
- ③. Relay OP2 output
 - N: No OP2 output
 - 1: Be used as SP1 count output 2: Be used as SP2 ON/OFF Alarm output
 - 3: Be used as BA1 batch count output 4: Be used as SU1 totalize count output
- ④. Relay OP3 output
 - N: NO OP3
 - 1: Be used as SP1 count output 2: Be used as SP2 ON/OFF Alarm output
 - 3: Be used as BA1 batch count output 4: Be used as SU1 totalize count output
- ⑤. Relay OP4 output
 - N: NO OP4
 - 1: Be used as SP1 count output 2: Be used as SP2 ON/OFF Alarm output
 - 3: Be used as BA1 batch count output 4: Be used as SU1 totalize count output
- ⑥. Power
 - B: AC85-265V
- ⑦. Communication
 - N: No communication M: RS-485 Communication (Modbus-RTU)

2. Dimension

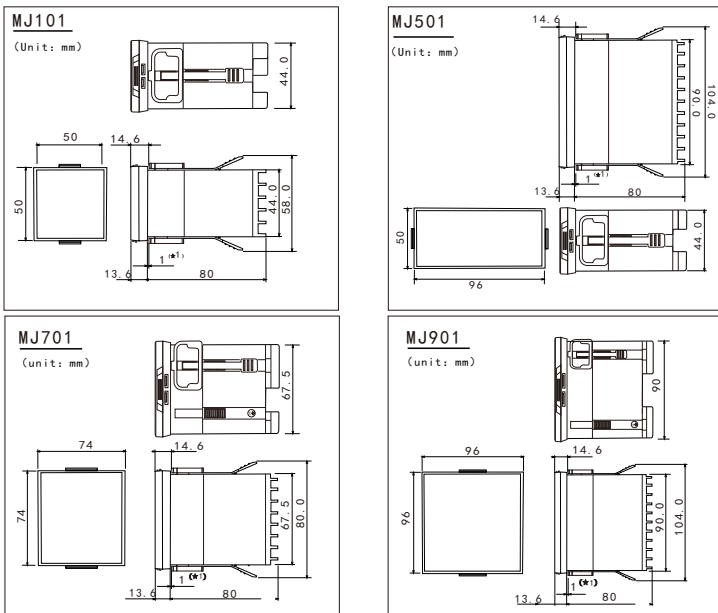

3. Wiring

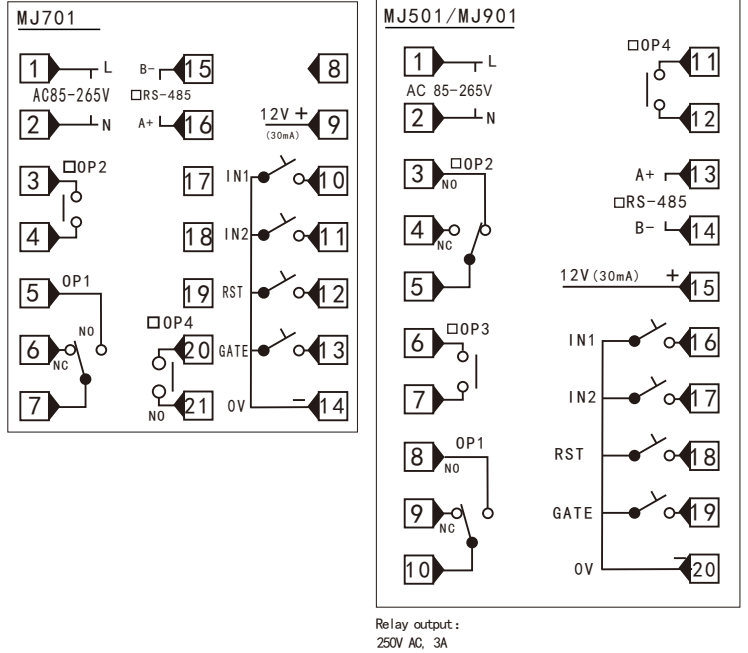

4. Panel Description

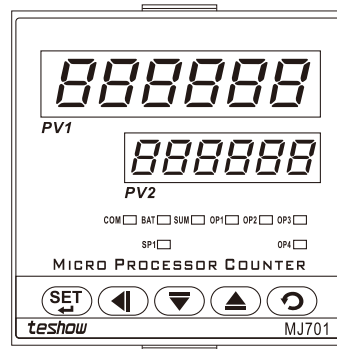

- PV1: Measure value (display #1 channel counting)
- PV2: Display PV2 set value
- COM: communication indication
- BAT: batch count display, PV2 display batch value
- SUM: totalize counter display, PV2 display totalize value
- SP1: SP1 display, PV2 display Sp1 value
- OP1: Relay OP1 output indicator
- OP2: Relay OP2 output indicator
- OP3: Relay OP3 output indicator
- OP4: Relay OP4 output indicator

- SET : Enter key and output method menu key
- ◀ : Shift key and manual reset zero key
- ▼ : Down key
- ▲ : UP key
- ↻ : Manual reset zero key, press key once count value is clear, output reset

5. SETTING

5.1 Enter the program of each function

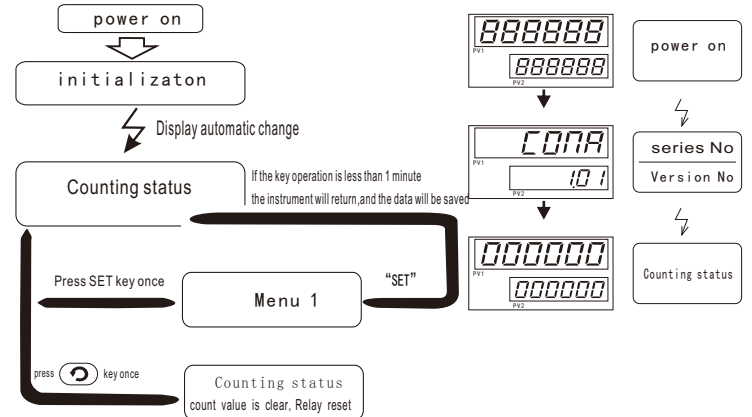

5.2 Change value For example set Sp1 from 0 to 200

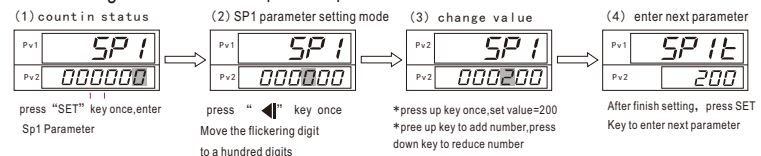

6. MENU

6.1 MENU 1

As shown on the right, press SET key once, then enter the menu 1

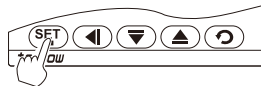

6.1.1 Menu 1 parameters adjustment:

The following parameter notations will be displayed in turn after press SET key each time.

The Parameters will not be saved after adjustment until exit the menu by press SET key

Notation	Parameter type	Description
SP1	Sp1 count value	Sp1 count set value
SP1t	Op1 Relay output and reset zero time	reset time: 0.01~99.99 second selectable
SP2	Sp2 ON/OFF alarm	ON/OFF Alarm Sp2 set value
SP2t	Op2 Relay output and reset time	reset time: 0.01~99.99 second selectable
BA1	Ba1 batch count set value	Ba1 batch count set value
BA1t	Op3 Relay output and reset time	reset time: 0.01~99.99 second selectable
SU1	Su1 totalize count set value	Su1 totalize count set value
SU1t	Op4 relay output reset time	reset time: 0.01~99.99 second selectable
UAD	UAD communication address query	Only used to query this machine communication address, pls enter Menu 4 if need modify address
LCK	Parameter lock and enter the password area of each menu	LCK=0, all parameters can be changed LCK=1, only change menu 1, the other parameters can't be changed LCK=12, press SET key can enter Menu 2 LCK=13, press SET key can enter Menu 3 LCK=14, press SET key can enter Menu 4

Note: the above parameters of Menu 1 will not all be showed according to different functions

6.2 Menu 2 On Menu 1, when LCK=12, press SET key can enter Menu 2



The following parameter notations will be displayed in turn after press SET key each time.

The Parameters will not be saved after adjustment until exit the menu by press SET key

Notation	Parameter type	Description
HZ	The max pulse input frequency limit HZ	Set the max frequency, 1-5000Hz can be set, Select the appropriate input frequency according to the on-site input signal to ensure that the count is right For example: Hz = 3000 means that the input signal frequency use range ≤ 3000Hz Note: When the low-frequency signal input, if it is set to high-frequency input, there may be tremor causes multiple counts, be sure to set the appropriate frequency before use to ensure the accuracy of counting Suggestion: When the low-frequency signal input, the Hz is set to 1~10
INT	Pulse inputs selectable	=0, single pulse input count when signal turn on (Input IN1 is up, IN2 is down) =1, single pulse input count when signal turn on, then disconnection (Input IN1 is up, IN2 is down) =2, double pulse inputs quadrature 90° (IN1/IN2) Up/Down count
UD	count/reverse count selectable	=U count mode =d reverse count mode
MUL	multiplier	PV Value=pulse value×mul mul set range 0.0001~99.9999
BAP	Batch count (Batch count value ratio coefficient)	Batch count PV1 ÷ BAP (BAP range: 1~999999) For example: 100 is set as one batch, then BAP=100
SUT	Power-off memory function	=0, no power-off memory function, start count from 0 when re-power =1, have power off memory function, start count from the value (power-off) Note: set sut from 0 to 1 need restart after power-off
dP	Decimal point settable	Set the position of decimal point, and the setting range is 0-5

6.3 Menu 3 in the "Menu 1", parameter LCK=13, press SET key can enter Menu 3

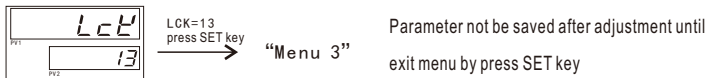

Notation	Parameter type	Description
PV2	Pv2 window display	=SP1: PV2 display SP1 set value, SP1 indicator is light, PV2 window display Sp1 set value =BA1: PV2 window display batch count value =SUM: PV2 window display totalize value SUM indicator is light PV2 window display totalize value
CSP1	Sp1 count output mode CSP1	=n: PV1≥SP1 set value, SP1 corresponding relay works immediately, The count value PV1 and relay need to be manually reset =r: PV1 ≥ SP1 set value, SP1 corresponding relay works immediately, The count value PV1 and relay need to delay Sp1t then reset =c: PV1≥ set value, SP1 corresponding relay works immediately, PV1 is cleaned at once, relay delay Sp1t then reset =Hn: PV1>SP1 set value, SP1 corresponding relay works immediately, PV1 and relay need manually reset =En: PV1=SP1 set value, SP1 corresponding relay works immediately, PV1 and relay need manually reset =Ln: PV1<SP1 set value, SP1 corresponding relay works immediately, PV1 and relay need manually reset
CSP2	Sp2 alarm output CSP2	the count value Pv1 alarm corresponding to Sp2 set value =n: PV1≥SP2, SP2 corresponding relay output. =An: PV1≥ (SP1-SP2), SP2 corresponding relay output =Hn: PV1≥ (SP1+SP2), SP2 corresponding relay output =En: SP1≥PV1≥SP2, SP2 corresponding relay output =Ln: PV1<(SP1-SP2), SP2 corresponding relay output =r: PV1≥SP2, SP2 corresponding relay output, delay Sp2t, then reset =Ar: PV1≥ (SP1-SP2), SP2 corresponding relay output delay Sp2t, then reset

Notation	parameter type	Description
CBA1	Ba1 batch count output CBA1	=n: batch count≥BA1, BA1 corresponding relay start work immediately, batch count and relay need manually reset =r: batch count≥BA1, BA1 corresponding relay start work immediately, batch count and relay need delay BA1t, then reset =c: batch count≥BA1, BA1 corresponding relay start work immediately, batch count is cleaned at once, relay need delay BA1t, then reset =Hn: batch count≥BA1, BA1 corresponding relay start work immediately, batch count and relay need manually reset =En: batch count≥BA1, BA1 corresponding relay start work immediately, batch count and relay need manually reset =Ln: batch count≥BA1, BA1 corresponding relay start work immediately, batch count and relay need manually reset
CSU1	Su1 totalize count output CSU1	=n: totalize count≥SU1 SU1 corresponding relay start work immediately, totalize count and relay need manually reset =r: totalize count≥SU1 SU1 corresponding relay start work immediately, totalize count and relay delay SU1t, then reset =c: totalize count≥SU1 SU1 corresponding relay start work immediately, totalize count is cleaned at once, relay delay SU1t, then reset =Hn: totalize count>SU1 SU1 corresponding relay start work immediately, totalize count and relay need manually reset =En: totalize count=SU1, SU1 corresponding relay start work immediately, totalize count and relay need manually reset =Ln: totalize count<SU1 SU1 corresponding relay start work immediately, totalize count and relay need manually reset

Note: the above parameters of Menu 3 will not all be showed according to different functions

6.4 Menu 4

in "Menu 1" . parameter LCK=14, press SET key can enter "Menu 4"



Notation	Parameter type	Factory setting	Description
ADD	communication Add	1	set communication address to 1-127
BAU	Communication Potter rate	9.6	Potter rate is 2.4K, 4.8K, 9.6K, 19.2K

7. Remark

7.1 Max frequency, Menu 2 HZ parameter

Set the max frequency, 1-5000Hz can be set, Select the appropriate input frequency according to the on-site input signal to ensure that the count is right
For example: Hz = 3000 means that the input signal frequency use range ≤ 3000Hz
Note: When the low-frequency signal input, if it is set to high-frequency input, there may be tremor causes multiple counts, be sure to set the appropriate frequency before use to ensure the accuracy of counting
Suggestion: When the low-frequency signal input, the Hz is set to 1~10, Crystal pipe input, set HZ=3000. the rotating encoder high-frequency input, set HZ=5000

7.2 Count input mode, Menu 2 INT parameter

Int=0: single phase input, count when signal connect, IN1 is up, IN2 is down



Int=1: single phase input, count after signal is on and off, IN1 is up, IN2 is down

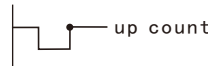

Int=2: two phase inputs: IN1/IN2 is up, IN2/IN1 is down
Phase difference between IN1 and IN2 is 90 degrees (for rotating encoder 90 degrees phase angle signal)

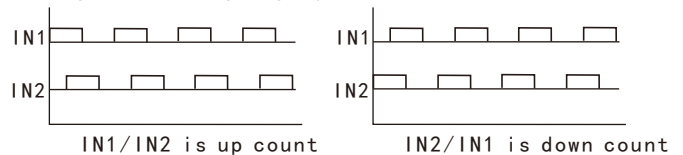

7.3 window PV2 mode can set freely the display content, menu 3 parameter PV2

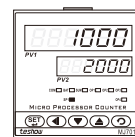

PV2=SP1
Sp1 set value mode
Pv2 window display Sp1 set value

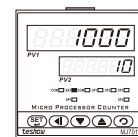

PV2=BAT
batch count mode
Pv2 window display batch count value

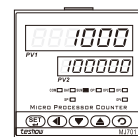

PV2=SUM
totalize count mode
Pv2 window display totalize count value